

Mesaj Kle

Impotans

1) Kontrevantman

- Ajoute kontrevantman nan mi yo epi nan twati kay'la.
- Ajoute kontrevantman nan mi solid yo nan chak bo, kote ki pa gen pot ou fenet.
- Kontrevantman yo dwe konekte nan sol kay'la ak nan tet poto yo.
- Byen konekte kontrevantman yo nan chak kwen epi nan kwazman yo. (Poto, chevron)



2) Koneksyon

- Byen konekte tol ak lat, lat ak chevon, chevon ak pout, pout ak kolon epi kolon ak fondasyon.



3) Tet Kay (Twati)

- Tout bwa ki fè kay'la dwe byen tache youn ak lòt.
- Byen kloure tòl yo sou bwa yo.



4) Fom

- Kembe fom kare ki senp epi ki ba.



5) Fondasyon

- Asire ke fondasyon fet sou yon teren ki janm et poto yo byen ankre ladanl .



6) Lokasyon

- Tasire nou ke anplasan kay la nan yo kote ki an sekirite.

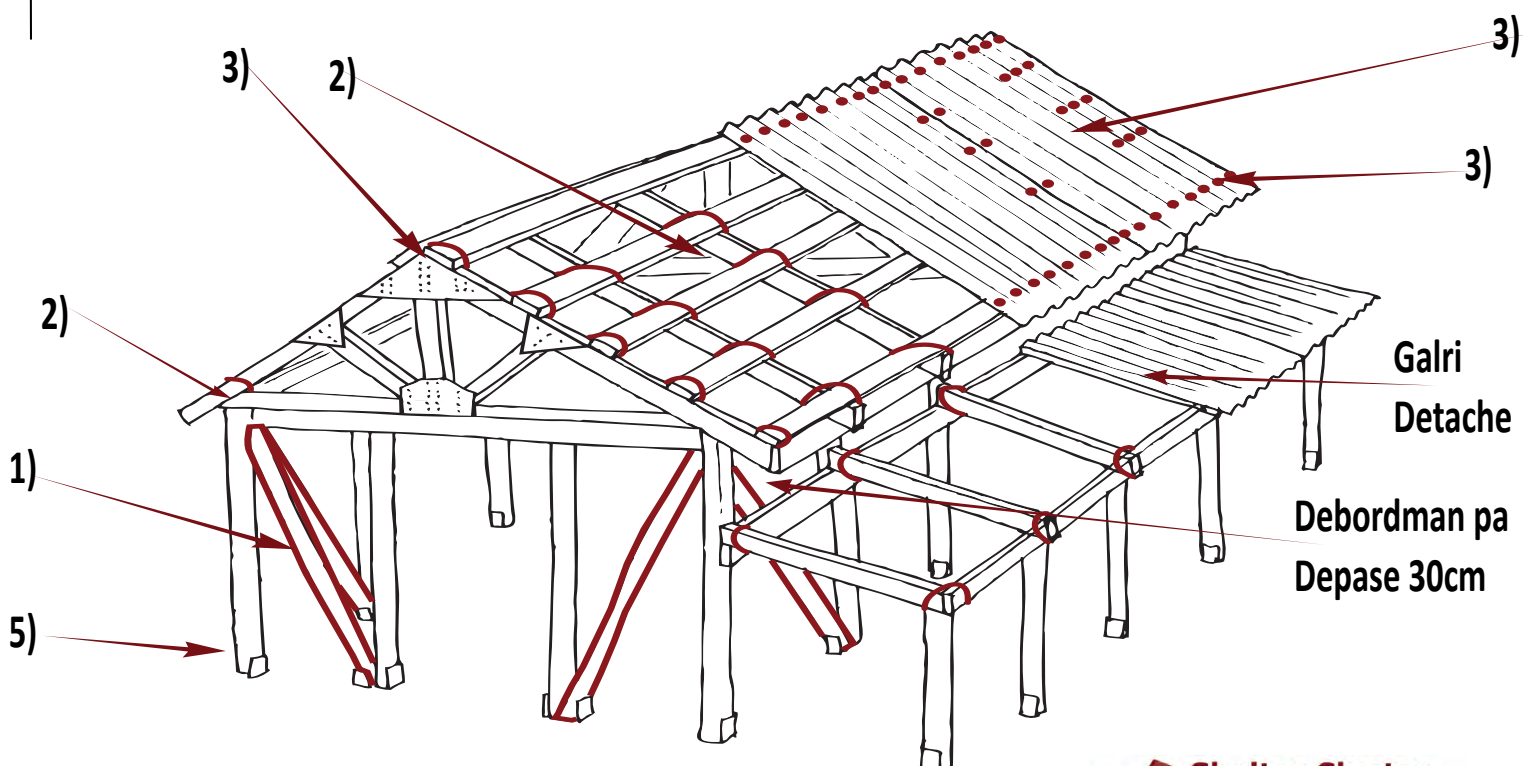

Shelter Cluster

ShelterCluster.org

Coordinating Humanitarian Shelter

1) KONTREVANTMAN

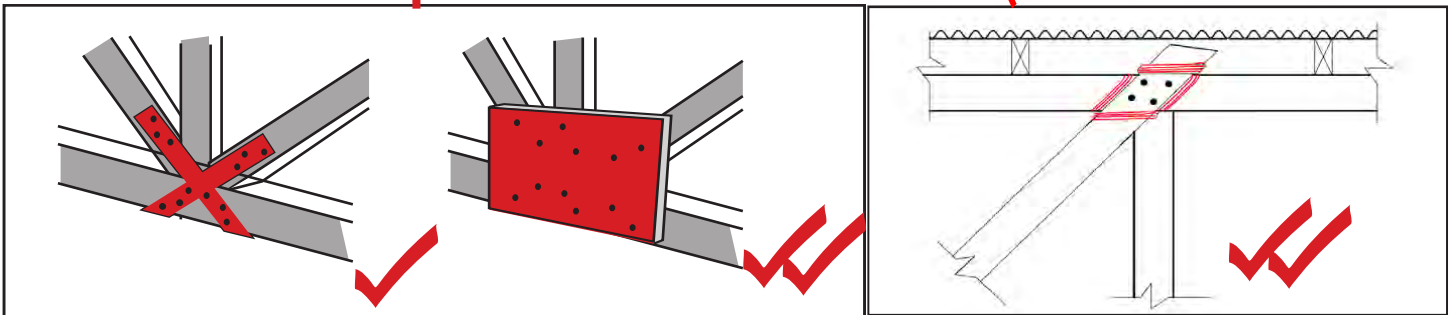
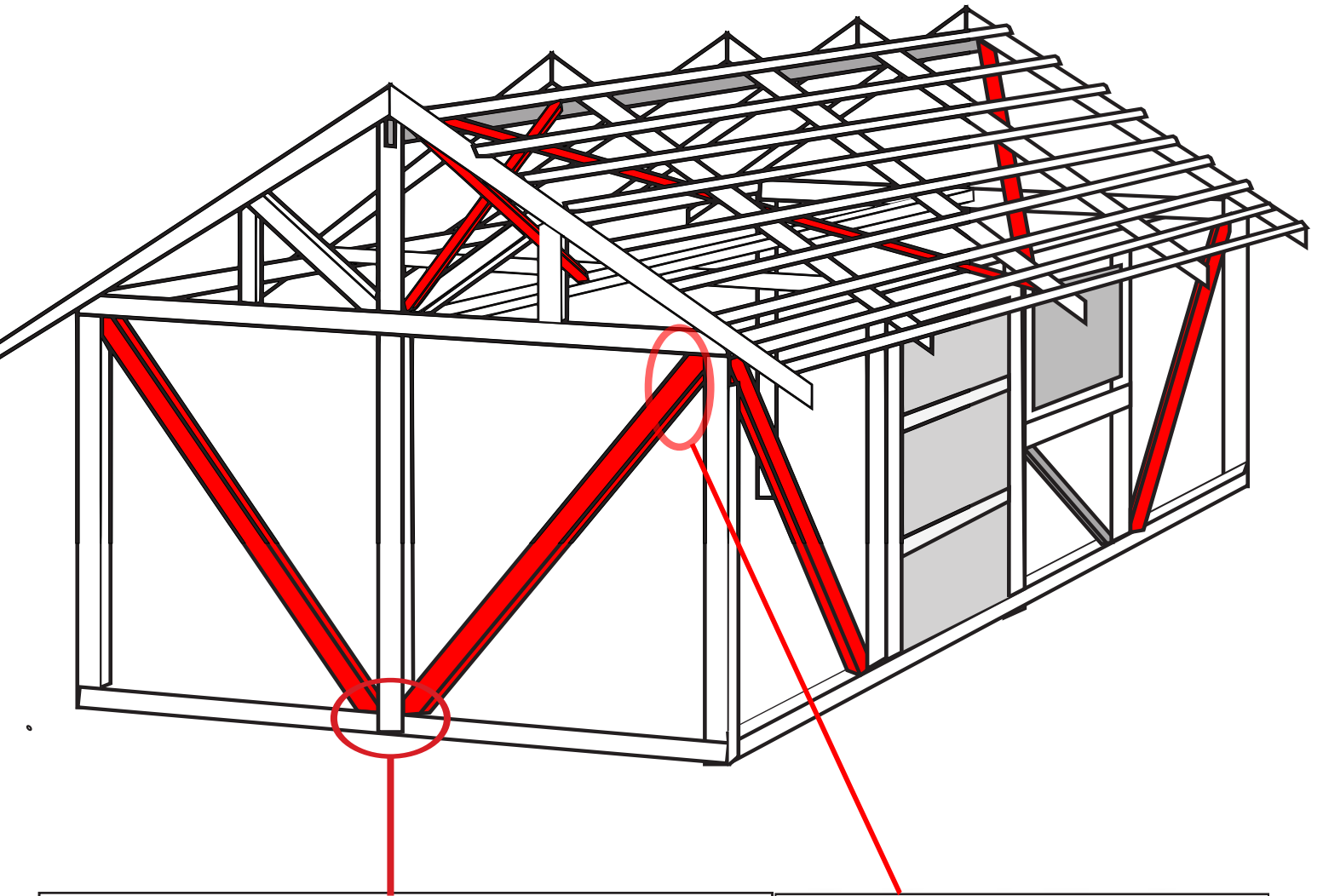
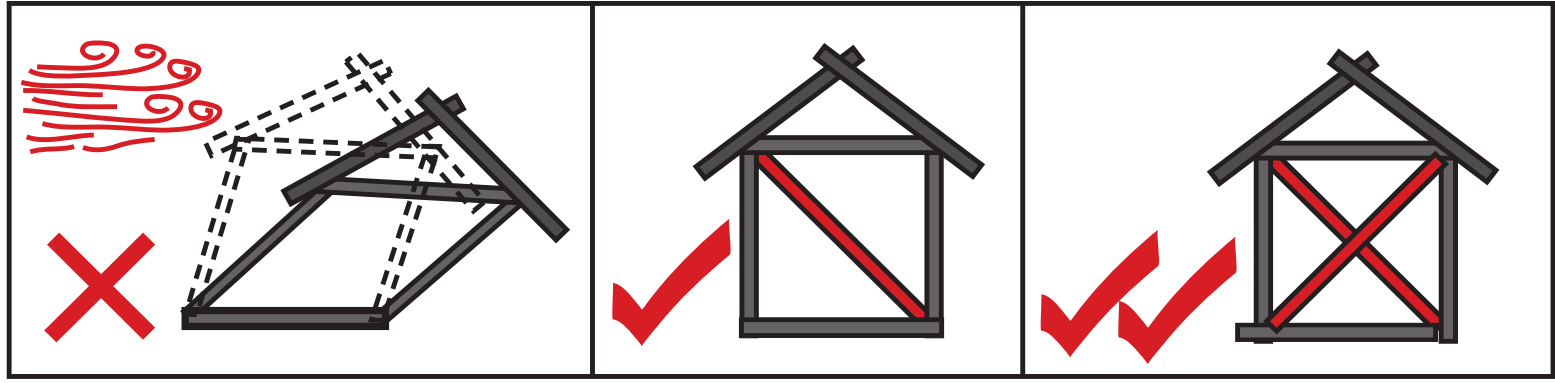

2) Konneksyons

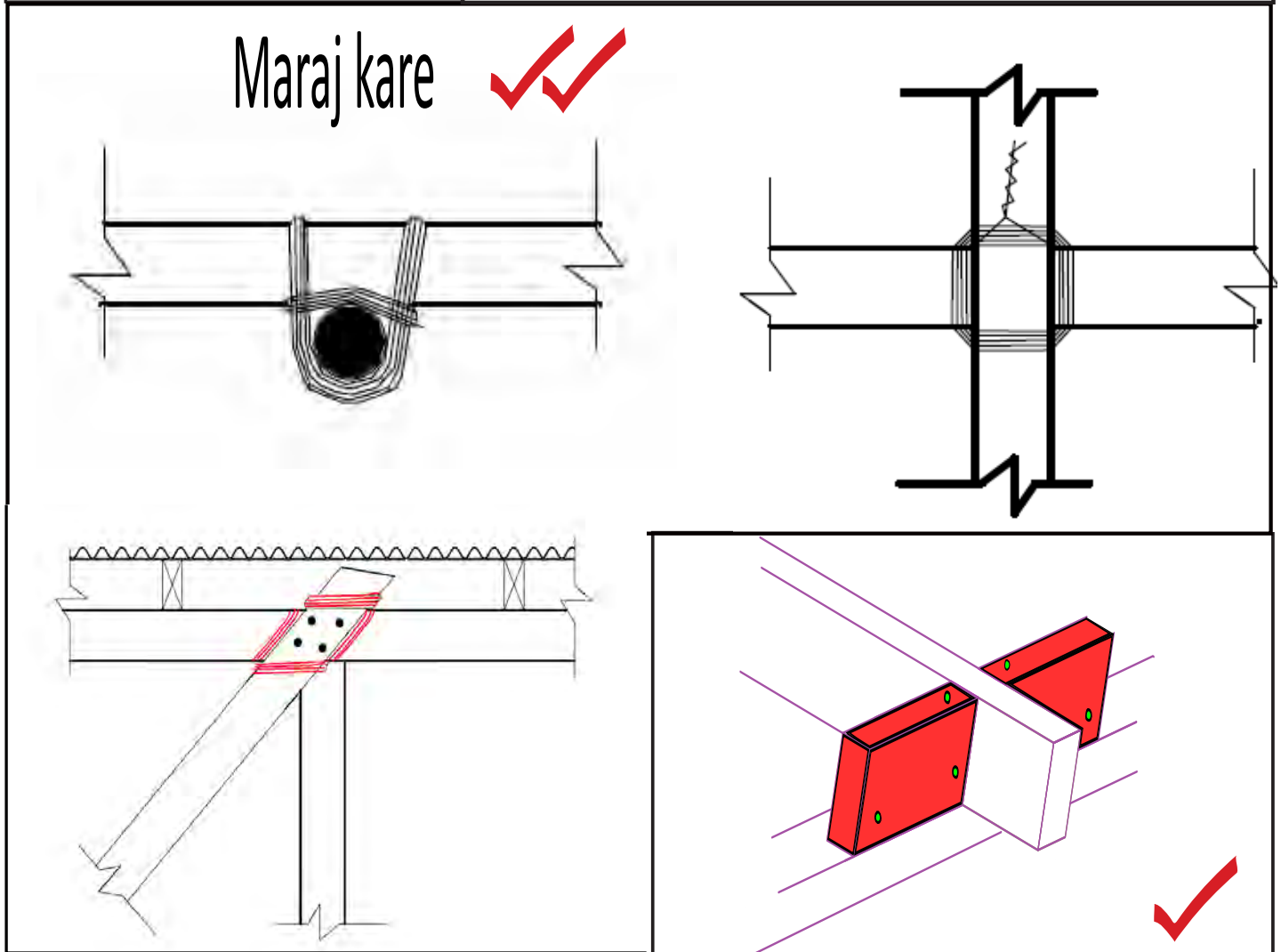
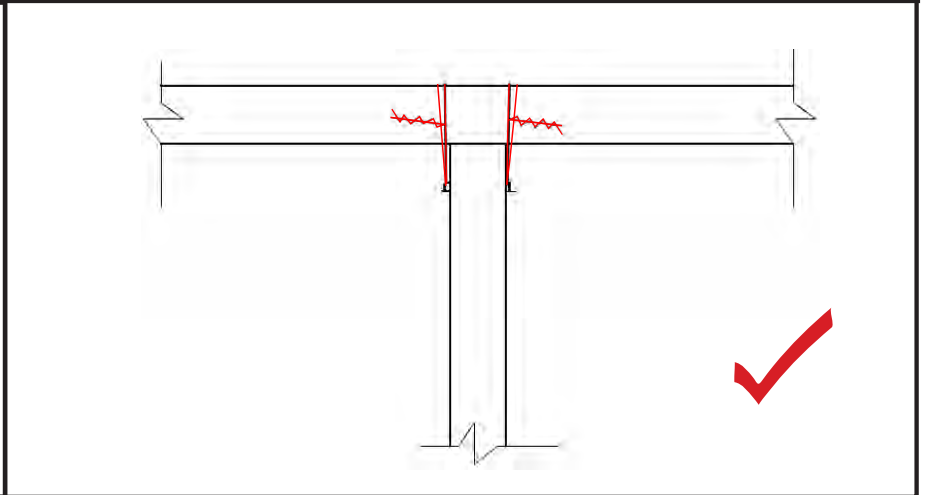
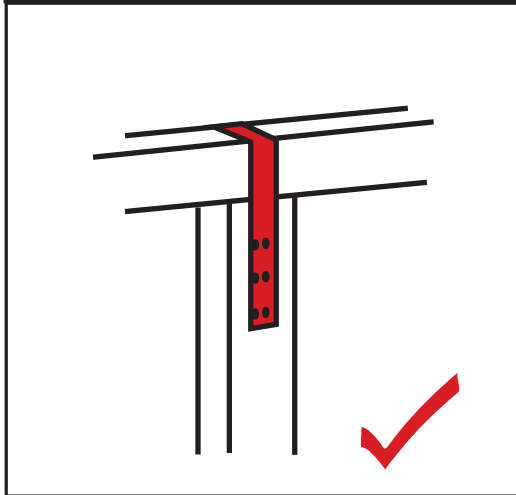
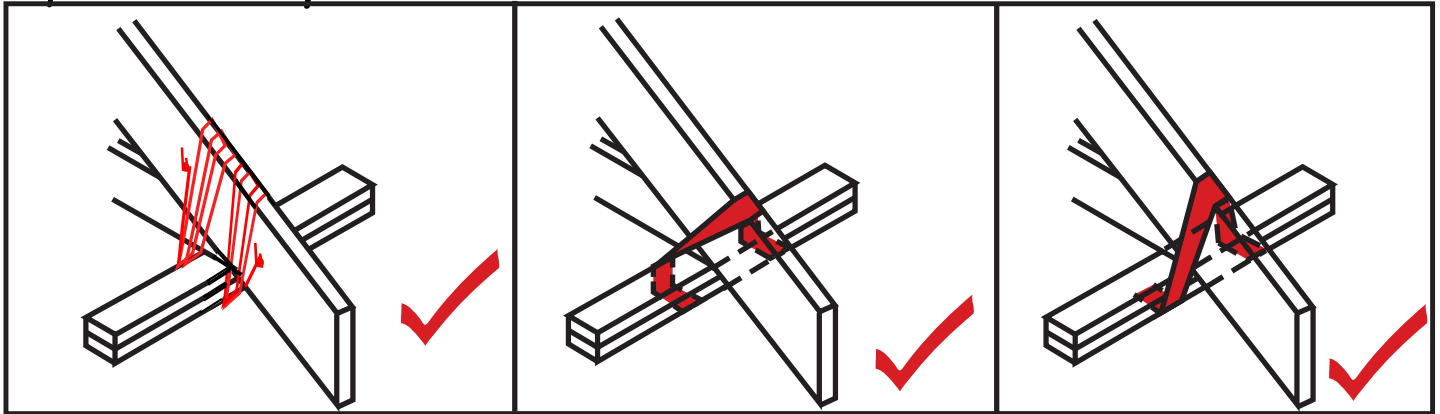

2a) KONEKSYON - KIJAN FÈ MARAJ KARE

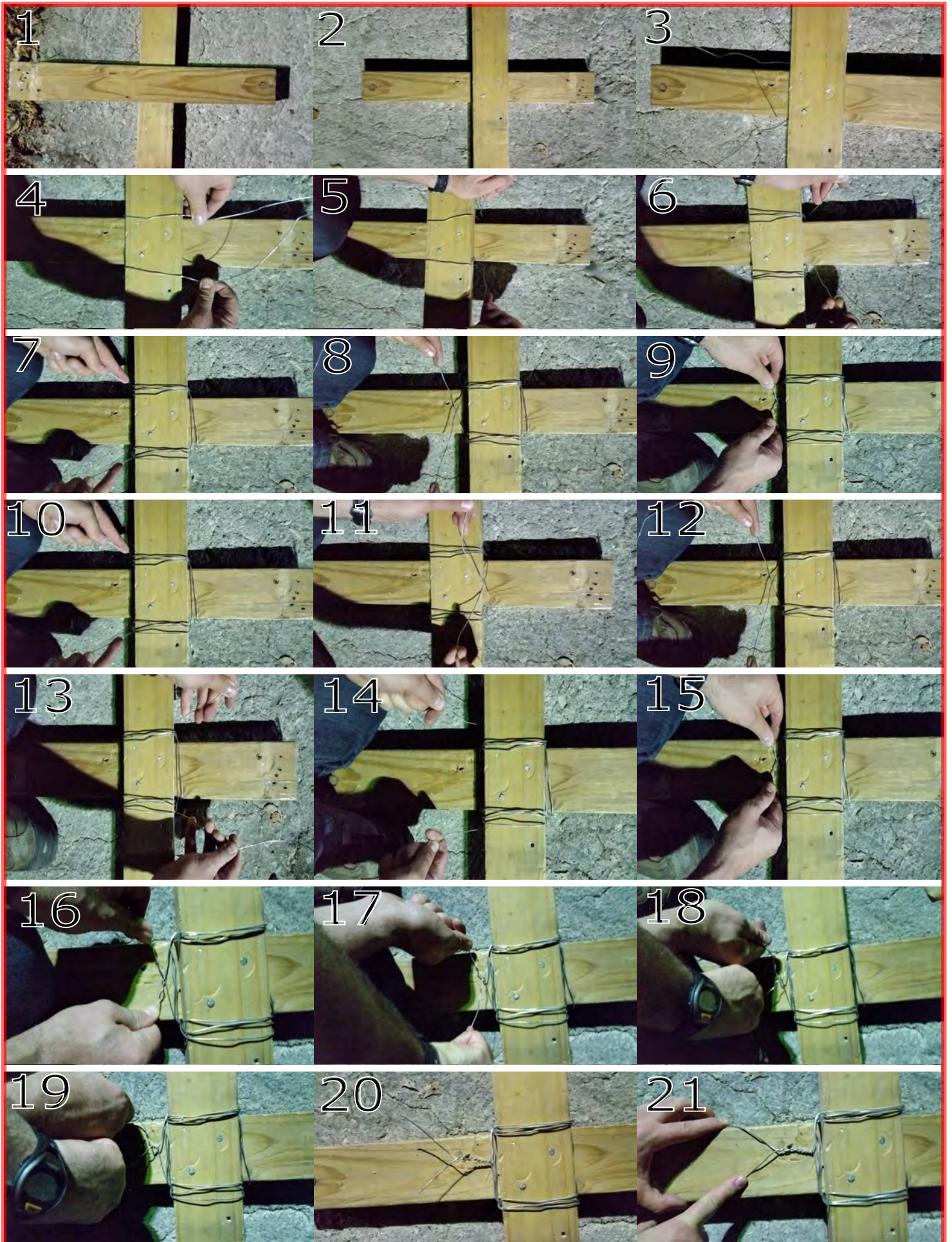

3) TÈT KAY (TWATI)

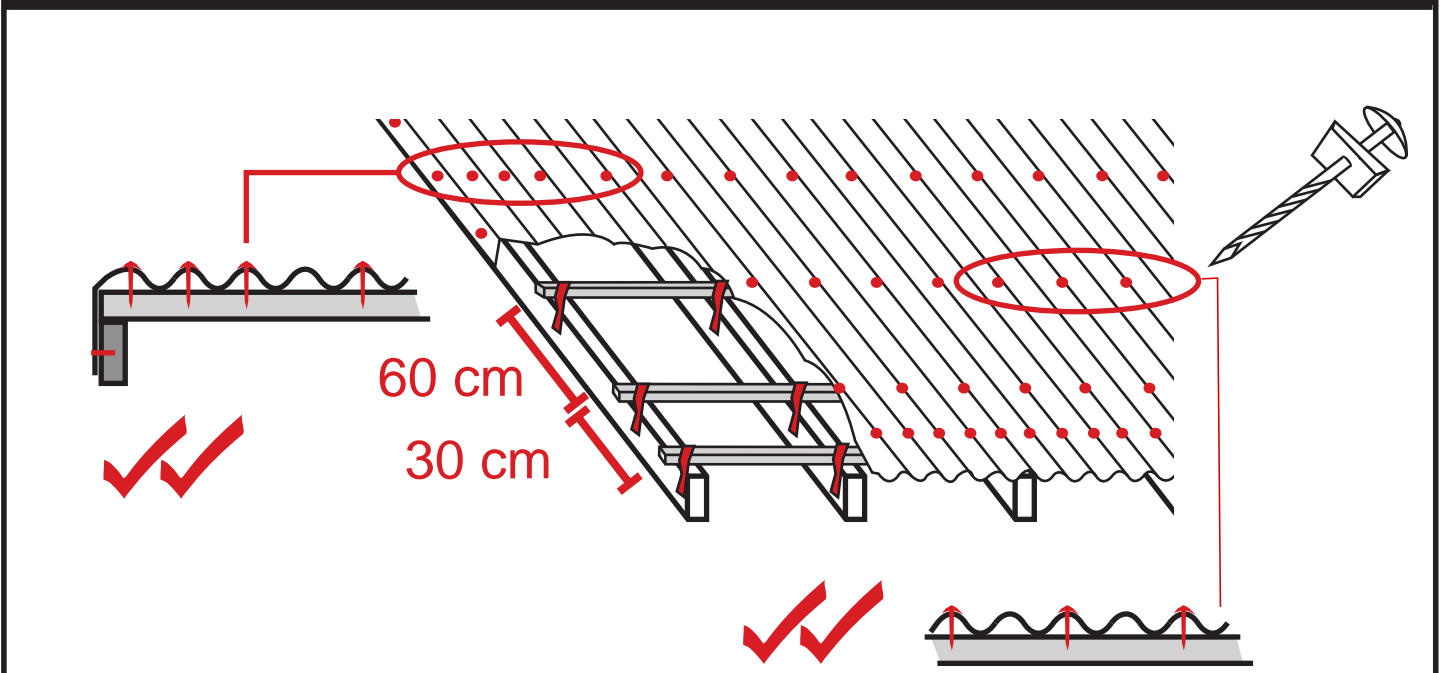
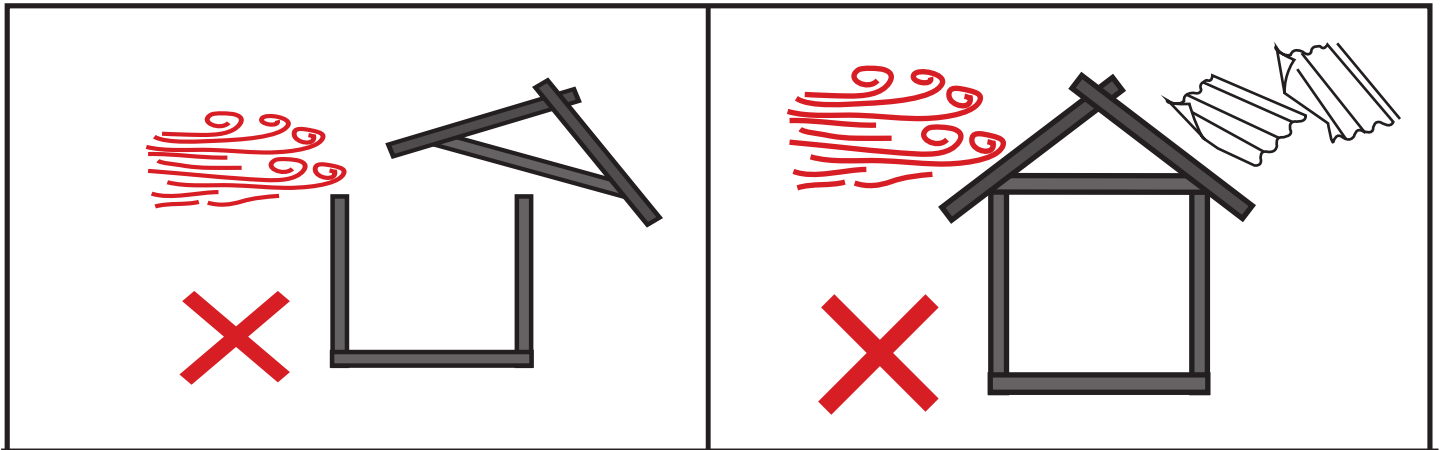

SIKLÒN



mi pinyon femen



mi pinyon ouvè



gran fenèt ouvè



avan twati endependan

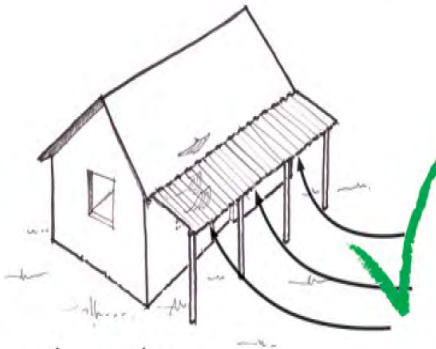

twati prensipal fe avan twati



Shelter Cluster

ShelterCluster.org

Coordinating Humanitarian Shelter

4) FORME KAY



✓ 26-40°

✓ 4 Pants

✓ Gade kay yo sou tet mon

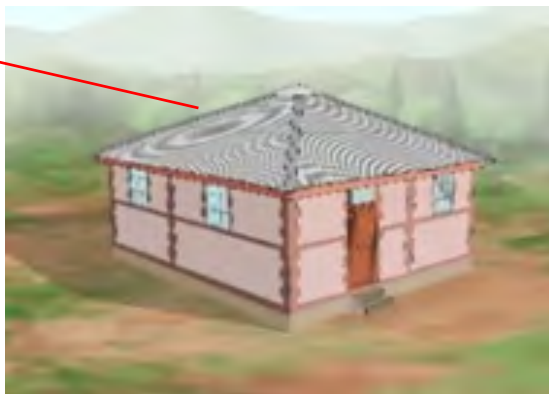

5) FONDASYONS

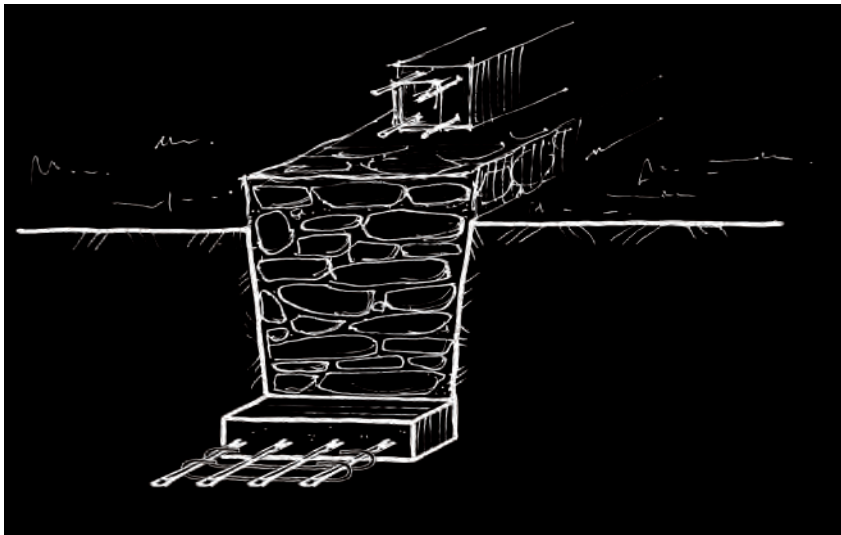
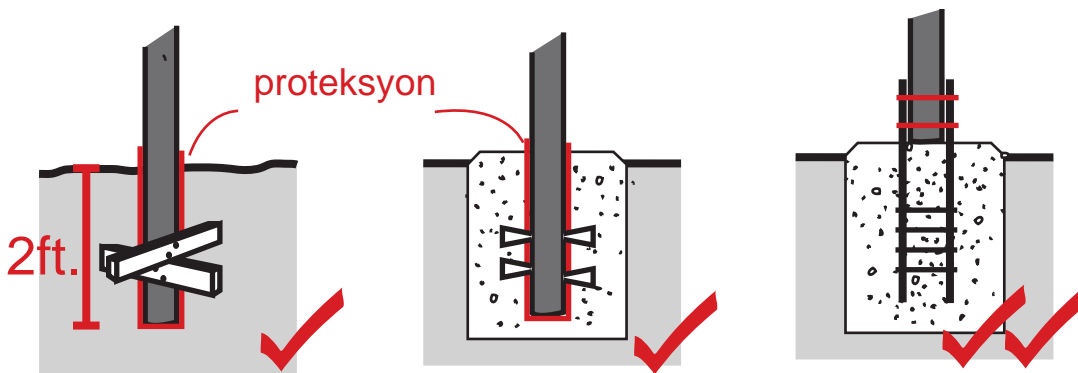
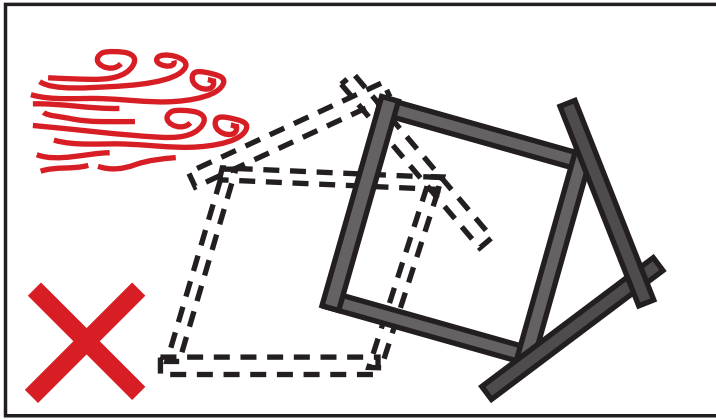

Mete sol'la sou bon teren.
Ankre poto yo anndan sol'la.

6) Lokasyon

CHWA TEREN NOU PRAL BATI SOU LI LA



pa bati sou mi soutyen yo



nan mitan mi soutènman



pa twò pre gwo pant



pa sou poto

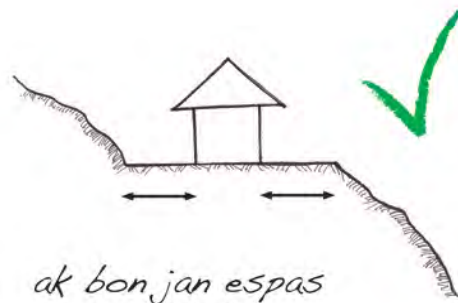

ak bon jan espas
sou chak bò



pa twò pre falèz ni ranbleyaj



pa sou ranblè tou fre

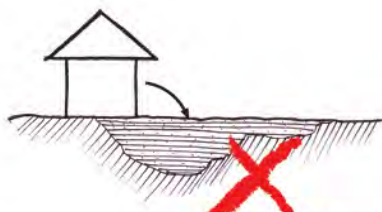

pa sou teren
melanje

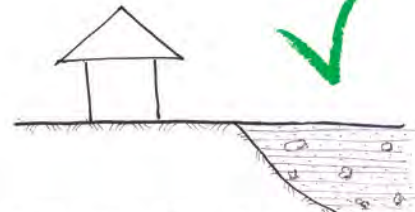

sou yon bon teren di e
san melanj



pa nan bafon

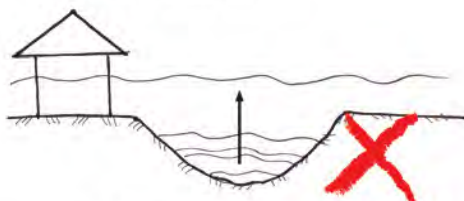

pa tou pre rivyè

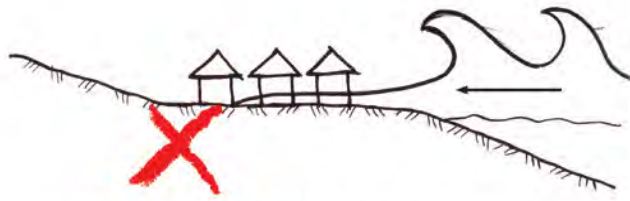

pa tou pre lanmè (tsounami)